

SCREENY 85 GC S S07

20.04.2026_rev.01



KE

SCREENY 85 GC S S07

KE



Awning with 85 square cassette (S07, S03, S04). The fabric can slide on cable guide (GC) or zip profile guide (GPZ).

Max dimensions 300x240 for GC version and GPZ single module; 600x240 for GPZ double module, wind resistance class 3/2 GC/GPZ according to EN 13561:2015.

Rollerbat fabric roller diameter 56 mm in galvanised steel with patented system for reducing creases in the fabric

Fixing to the building is done on the wall or ceiling (GPZ-GC), or freestanding (GPZ).

Winch or motorised movement by means of a tubular motor (optional).

In the motorised version it is possible to install light sensors and anemometers as well as connection to remote controls and control systems via smartphone apps.

Curtain profiles made from extruded aluminum alloy 6060, brackets in die-cast or shell-molded aluminum, and stainless steel screws.

Parts painted with polyester resin-based epoxy powders.

Choice of fabrics to KE sample book.

Choose between RAL 9010 White, RAL 9006 Aluminium and other optional RAL colors.

CE marking according to EN 13561:2015.



TECHNICAL INFORMATION

Wall installation

A-A

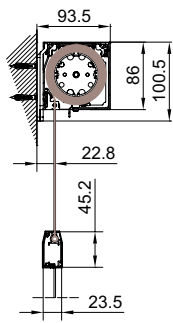

Wall installation

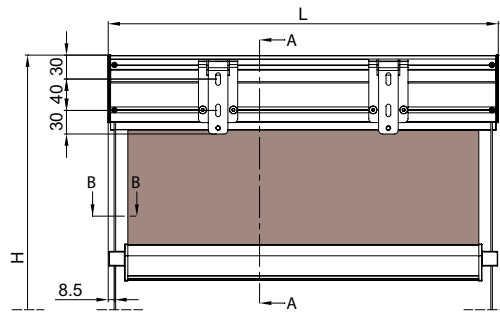

Wall installation

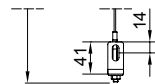
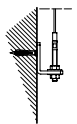
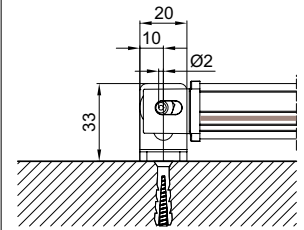

Wall installation

Wall installation

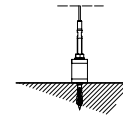
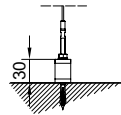
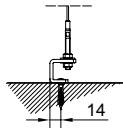

Wall installation

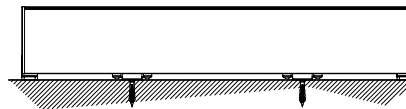

Wall installation

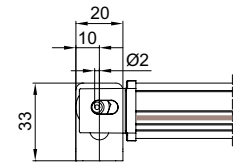

Ceiling installation

A-A

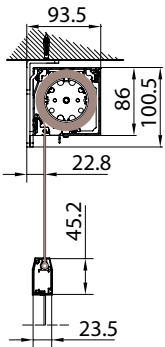

Ceiling installation

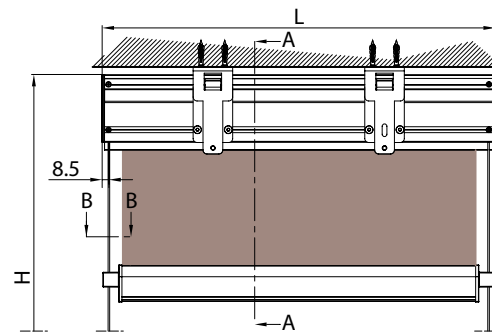

Ceiling installation

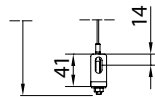
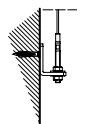
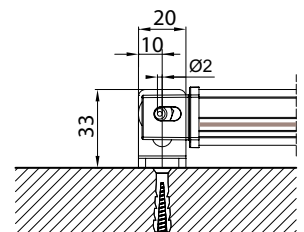

Ceiling installation

Ceiling installation

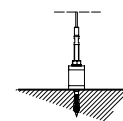
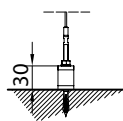
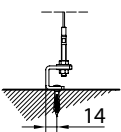

Ceiling installation

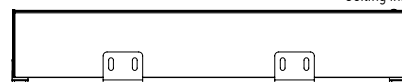

Ceiling installation

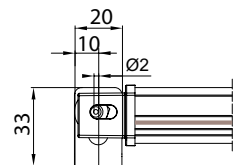



WIND RESISTANCE

The wind resistance of an exterior shade system is characterized by its ability to support defined loads by simulating wind with positive or negative pressure. In order to define a correlation between the wind resistance class according to the classes defined by the technical standard EN 13561 and the wind speed expressed in Km / h, a comparative table with the Beaufort scale is used. The Beaufort Scale classifies winds according to the speed at which they blow. Wind speed is measured in kilometers per hour (km / h) or in nodes using a measuring instrument, called anemometer, at a height of about 10 meters above the ground.

	DESCRIPCIÓN	VELOCIDAD DEL VIENTO m/sec	VELOCIDAD DEL VIENTO m/sec	VELOCIDAD DEL VIENTO Nodi	EFECTOS DEL VIENTO EN LA TIERRA	EN 13561
4	Viento moderado	5,5 - 7,9	20 - 28	11 - 16	Se levanta polvo y trozos de papel; se mueven las ramas pequeñas de los árboles.	Clase 1
5	Fresquito, Brisa fresca	8,0 - 10,7	29 - 38	17 - 21	Los arbustos con hojas empiezan a moverse; el agua forma ondas en su superficie.	Clase 2
6	Viento frío	10,8 - 13,8	39 - 49	22 - 27	Se mueven las ramas gruesas; es difícil usar el paraguas.	Clase 3
7	Viento fuerte	13,9 - 17,1	50 - 61	28 - 33	Los árboles empiezan a ondear; se camina con dificultad contra el viento.	Clase 4
8	Viento fuerte	17,2 - 20,7	62 - 74	34 - 40	Las ramas de los árboles se rompen; es imposible caminar contra el viento.	Clase 5
9	Borrasca fuerte	20,8 - 24,4	75 - 88	41-47	Se pueden observar daños en la estructura de los edificios (caída de tejas o cubiertas de las chimeneas).	Clase 6

Please note: in wind above the maximum class rating, it is necessary to retract the fabric or move blades to upright. For the evaluation of wind resistance of the perimeter closures (Vertika, Vertika Prime, Line glass) refer to the performance declarations of the products themselves. The opening and closing of the screens can be controlled by installing sensors (sun, wind, rain). These aids do not replace the need for visual monitoring and taking manual action to make the awning safe when winds or loads exceed the product's limits. Therefore, the safety of the product is not guaranteed by the use of sensors.



The KE painting process includes high quality standards, with an 8-stage pre-treatment that includes degreasing, deoxidation, and protective treatments before painting. Thanks to this last phase, components and profiles are further guaranteed against particularly severe environmental situations. At the end of the process the profiles and components are painted with polyester resin-based epoxy powders. Treated components are periodically tested in salt spray according to the ISO 9227 standard to confirm conformity and consistency of the process. The European product standard EN 13561: 2015 defines corrosion resistance classes of the metal parts that make up the product according to the table below. Tests performed on the painted components and profiles allow us to classify the product in the maximum class achievable according to EN 13561: 2015, C2 / 4 (48 h - internal components, 240 h - external components).

Equipped with the most modern process control systems including continuous monitoring in which the working parameters are recorded and corrected every 2 minutes, the new painting process guarantees the high quality characteristics of the product while minimizing the risk of environmental pollution. This is a choice born from the desire to always keep up with technology while guaranteeing operator safety and low environmental impact. Thanks to nanotechnologies, the implemented coating constitutes an excellent base for anchoring paints, ensuring excellent adhesion and resisting corrosion. The plant in which aluminum or galvanized steel products with a length of up to 7 meters can be treated, includes 7 treatment tanks, 1 double compartment drying oven, 1 polymerization oven and 1 purification plant for waste water treatment. The real focus of the plant, however, is the two powder coating booths, each with 4 stations for manual retouching. The booths allow greater production continuity, thanks to a drastic reduction in required stops for color changes.

CORROSION RESISTANCE

Classes	1	2	3	4
Internal components	24	48		
External components		48	96	240

COLOURS



When working with color, we know that our whole world is defined by light. And color is nothing more than a breakdown of light. Objects reflect back to our eyes only the color that defines it. This is why it is so important to recognize the close link between color and matter. For this project, there are three keywords that guide the research: Words, Places, Matters.

WORDS: Naming colors is important to make them familiar and easily recognizable.

PLACES: Places define colors. Recognizing different types of places is a starting point for defining and suggesting color combinations.

MATERIALS: Objects do not exist in isolation, but rather match the environment around them: analyzing the materials that make up the environment itself helps us to make decisions; to decide, for example, if the character of a place is false or if instead it is genuinely artistic.

COLOURS RAL



● Ral standard (without supplement)

COLOURS

STRUCTURE COLORS	PLASTIC COLORS
RAL 9010 WHITE MATT	White
RAL 9010 WHITE	White
RAL 1013 OFF WHITE MATT	Ivory
RAL 1013 OFF WHITE	Ivory
RAL 9006 ALUMINIUM MATT	Black/Gray
RAL 9006 ALUMINIUM	Black/Gray
RAL 9007 DARK ALUMINIUM MATT	Nero
RAL 9007 DARK ALUMINIUM	Black/Gray
RAL 8014 CLASSIC BROWN MATT	Black
CORTEN ROUGH	Black
RAL 7016 IRON MATT	Black
CARBON ROUGH	Black
RAL 9005 BLACK MATT	Black
RAL 9003 COTTON MATT	White
RAL 9002 WHITE GRAY MATT	White
RAL 7038 RESIN MATT	Black/Gray
RAL 7044 NATURAL STONE MATT	Black/Gray
RAL 7030 WARM GREY MATT	Black/Gray
RAL 7042 GREY STONE MATT	Black/Gray
RAL 1015 SAND MATT	Ivory
RAL 1019 WASHED WOOD MATT	Black
RAL 7006 DUST MATT	Black
RAL 3007 BLACK RED MATT	Black
RAL 8017 GROUND MATT	Black
RAL 8019 BIGHT BROWN MATT	Black
RAL 7021 OFF BLACK MATT	Black
RAL 5000 MONLIGHT MATT	Black
NCS S1515-R80B SKY ROUGH	Black
NCS 1050-B30G POOL MATT	Black
RAL 6025 LEAF MATT	Black
RAL 6003 WOOD MATT	Black
RAL 6007 MIMETIC MATT	Black
RAL 5002 PRIME B MATT	Black
RAL 3002 PRIME R MATT	Black
RAL 1023 PRIME Y MATT	Ivory

N.B. For colors not listed, KE reserves the right to select the best possible color combination between the frame and the available plastic components.



There is increasing demand for high-performance buildings that have a very low energy consumption and use energy derived from renewable sources. In particular, the limitation of solar heat gain is one of the most important aspects of summer thermal comfort. Solar shading plays an essential role in this concept. The gtot value determines the ability of the solar shield to maintain, in an environment directly exposed to solar radiation, a more comfortable temperature than that which would occur with the presence of glass alone. The solar heat gains are directly proportional to the total transmittance of solar energy gtot, a value that depends on the glazing and external shielding. The European product standard EN 13561: 2015 and the EN 14501 standard identify 5 energy performance classes as shown in the table below.

Effect of GTOT on thermal comfort					
Gtot value	$\geq 0,50$	$\geq 0,35 \text{ e } < 0,50$	$\geq 0,15 \text{ e } < 0,35$	$\geq 0,10 \text{ e } < 0,15$	$< 0,10$
Class	0	1	2	3	4
	very mild effect	Mild effect	Moderate effect	good effect	very good effect

Each KE product has a Gtot value according to the shading fabric / profiles used. For details, refer to the information provided with the technical data sheet of the fabric and the CE label.

FABRICS

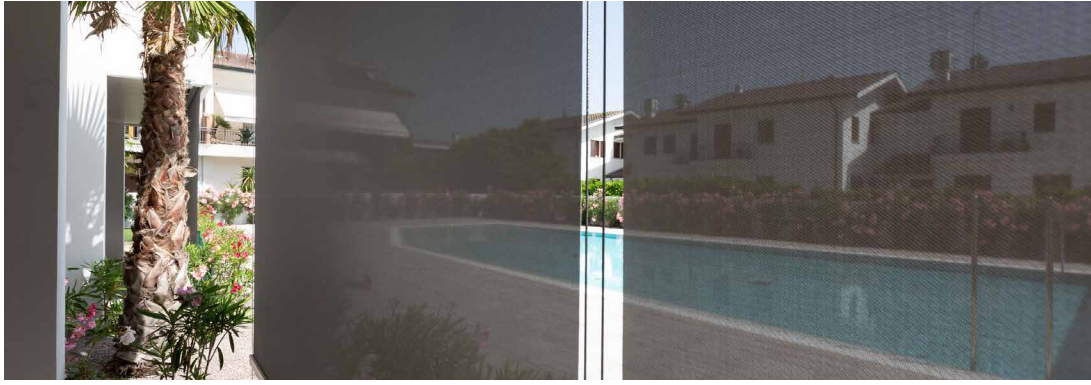

KE

Thermal comfort blends perfectly with beautiful style thanks to the more than 500 high performance fabrics available. A wide variety of colors, styles and solar shading factors allow for a system that meets your specific needs. All fabrics are CE Certified according to the EN 13561 and EN 14501 technical standards.

N.B.
See the Fabric Guide for further fabric specifications.

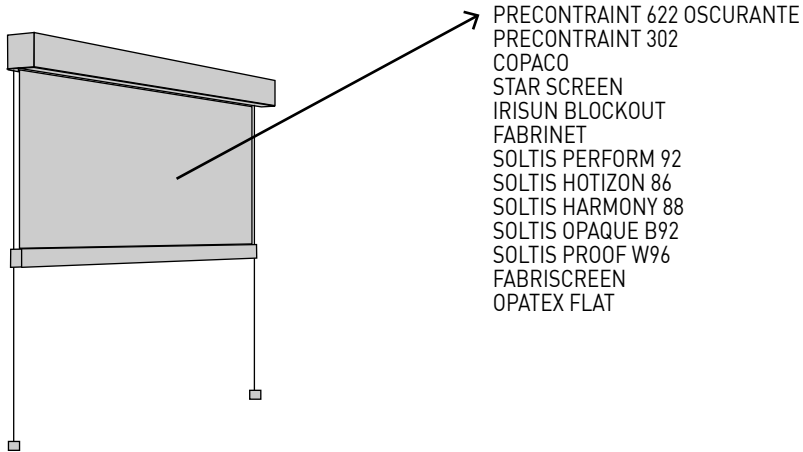

Fabrics

- PRECONTRAIT 622 OSCURANTE
- PRECONTRAIT 302
- COPACO
- STAR SCREEN
- IRISUN BLOCKOUT
- FABRINET
- SOLTIS PERFORM 92
- SOLTIS HOTIZON 86
- SOLTIS HARMONY 88
- SOLTIS OPAQUE B92
- SOLTIS PROOF W96
- FABRISCREEN
- OPATEX FLAT



ENJOY THE OUTDOORS

DICHIARAZIONE DI PRESTAZIONE

N. 00001-CPR-2025-03-25

Ai sensi dell'Allegato III del Regolamento (UE) n.305/2011 del 9 marzo 2011
modificato dal Regolamento Delegato (UE) n.574/2014 del 21 febbraio 2014

SCREENY HIDE

Uso previsto del prodotto: **Tende per uso esterno**

Nome e indirizzo del fabbricante: KE PROTEZIONI SOLARI S.r.l., Via Calnova 160/a, Noventa di Piave (VE) – Italia

Sistema di valutazione e verifica della costanza di prestazione: **4**

Specifica tecnica armonizzata: EN 13561:2015 – Tende esterne e tendoni – Requisiti prestazionali compresa la sicurezza

Classificazione secondo Prospetto 1 - §4.1 EN 13561:2015:

Classi di resistenza al vento	0	1	2	3	4	5	6
Pressione nominale del vento p_N (N/m ²)	<40	40	70	110	170	270	400
Pressione di sicurezza del vento p_S (N/m ²)	<48	48	84	132	204	324	480
Velocità massima del vento [km/h]	<25	25	35	45	55	70	90

Prestazione dichiarata:

Codice di identificazione unico del prodotto-tipo	Dimensioni massime		Classe di resistenza al vento	Specifica tecnica armonizzata
	L (cm)	H (cm)		
SCREENY HIDE H1D	450	300	6	UNI EN 13561:2015
SCREENY HIDE H2F	450	300	6	UNI EN 13561:2015
SCREENY HIDE H3F	450	300	6	UNI EN 13561:2015
SCREENY HIDE H4D	450	300	3	UNI EN 13561:2015
SCREENY HIDE H4F	450	300	3	UNI EN 13561:2015
SCREENY HIDE H4C	500	300	3	UNI EN 13561:2015

Trasmittanza totale di energia solare g_{tot} : fare riferimento al valore riportato in etichetta CE in base al tipo di tessuto utilizzato.

La fornitura dei prodotti sopra indicati è conforme all'insieme delle prestazioni dichiarate.

Si rilascia la presente dichiarazione di prestazione in conformità al regolamento (UE) n.305/2011 sotto la responsabilità esclusiva del fabbricante sopra indentificato.



EN 13561:2015

KE PROTEZIONI SOLARI S.r.l.



EN ISO 9001 _ Quality

KE has adopted a Quality Management System compliant with EN ISO 9001 requirements in order to maintain and increase quality and meet the highest customer expectations. This continuous improvement, through the control of all processes and careful evaluation of risks and opportunities, engages the entire organization in the development of systems to ensure the safety and reliability of the product and in the search for innovative solutions and technologies.

OHSAS 18001 _ Safety

KE has activated a Safety Management System as an integral part of its work organization, committing itself to organizing the entire structure in order to pursue the objectives of continuous improvement in terms of safety and health protection. Training, knowledge and compliance with current legislation on health and safety at work, cooperation and collaboration and preventive activities are actively pursued in order to minimize the possibility of non-compliance.

EN ISO 14001 _ Environment

KE is ISO 14001 certified for environmental management and strives to be an example of respect for environmental resources and for the continuous improvement of its environmental management system. It is committed to continuous improvement and pollution prevention in compliance with applicable laws, regulations and standards; systematically detects any environmental impact of manufacturing processes, promotes the culture of recovery and recycling in the company and in the related production chain.

CE MARK _ EN 13561

The CE marking of outdoor awnings is a signal to the Consumer that the product can be sold freely in the EU single market, as it complies with Community provisions which recognize safety as the priority of every product that has this agreed upon reference standard. Verification of wind resistance capacity and the clear indication of the ability of the awning to contribute to the energy savings of the building (Gtot), are some of the commitments that the manufacturer makes to a product that has earned the CE marking. The name of the manufacturer, the reference standard (in our case EN 13561) accompany a product that is properly adapted to European indications.

CE MARK _ EN 1090-1

KE extended the CE marking in 2015 to stationary awnings, which are among the aluminum structural components covered by the international standard EN 1090-1. This marking reflects our use of rigorous structural design and manufacturing with qualified processes, adequate industrial resources and qualified personnel.



The KE B2B order system is a simple and intuitive service for placing orders conveniently online. An attractive graphic design, numerous functionalities and an easy and intuitive use mode that allows to access in real time to all the information related to the history of the orders and to the processing of the current ones. With the Cad Lite 3D Configurator you can configure Genius and Bioclimatica models thanks to a constantly updated online catalogue. Thanks to an easy-to-use interface, it also allows you to formulate a complete quote with minimal error.

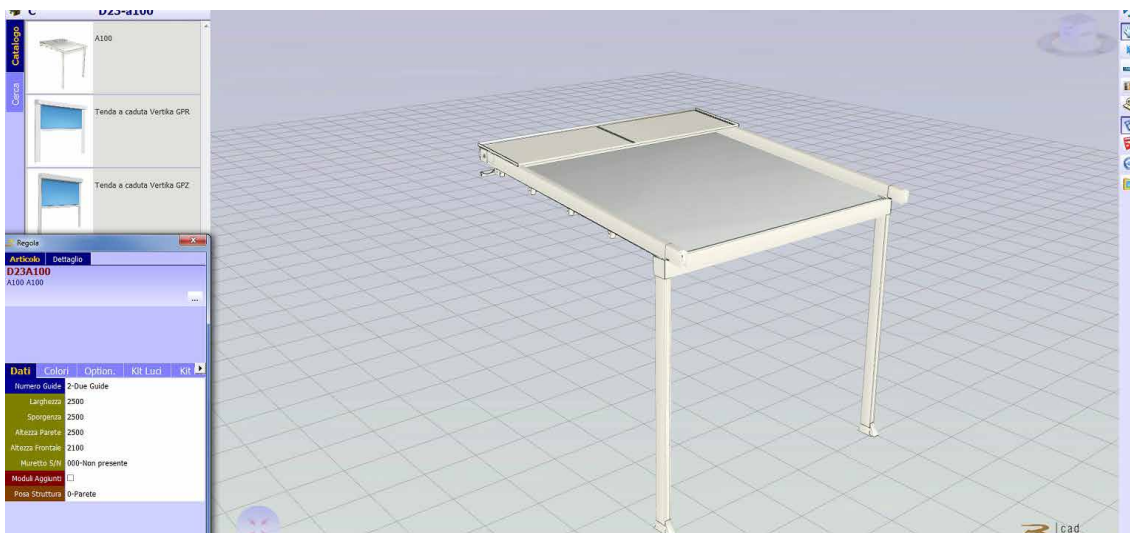



Home > Ambienti

Ambienti

La nostra missione è creare nuovi spazi outdoor da vivere in totale armonia. Grazie alle nostre **coperture solari e alle strutture per esterni personalizzate, potrai arredare con stile il tuo terrazzo, giardino, attico, ma anche modulare...** [Leggi di più](#)



BIM technology improves the working method of designers and is now the main source of information for the realisation of a project. With BIM the model is generated in a "parametric 3D" from which a series of information such as 2D views, elevations, sections but also metric calculations and much more can be automatically derived. On the KE website you can find the BIM gallery of the main KE models, the certifications and all the useful technical documentation for each product: www.keoutdoordesign.com

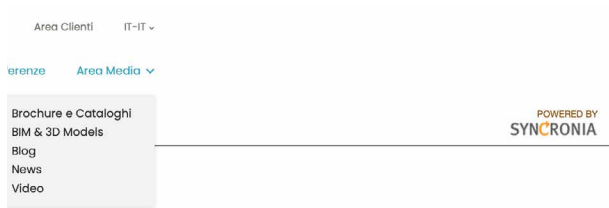



**A GROUP,
A VISION,
A GROUP IN EVOLUTION**

Since 1987, KE has been designing and manufacturing arm awnings, cassette awnings, drop awnings, canopies, shelters and is specialised in shading structures that enhance the liveability of outdoor spaces, up to the redesign and restyling of urban furniture. Both for the variety of the range and the depth of the configurations, KE is a manufacturing reality able to satisfy the most demanding requests the most demanding requirements of designers, architects, window and door manufacturers, upholsterers and outdoor professionals.

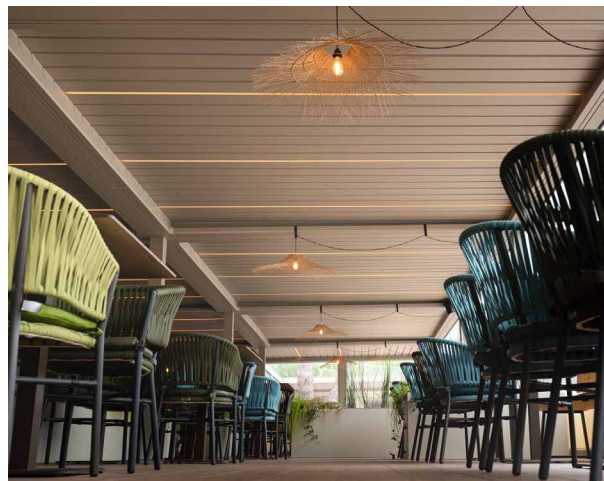

Improving the experience

With KE's professionalism and experience you can rely on quality products designed to enhance your customers' outdoor experience. With KE it will be easier to live the outdoor space in perfect harmony with the surrounding environment, widening the viewpoints and ensuring maximum comfort in all seasons.