

**SCREENY
130 GC
CABRIO
S27**

22.02.22_rev. 00



KE
ENJOY THE OUTDOORS

SCREENY 130 GC CABRIO S27



Awning with 130 box round or square (S20, S22, S23, S41, S70, S24), also available in "cabrio" version (S26, S27). The curtain can slide on cable guide (GC), "Unica" zip profile guide (GPZ) or Pratika guide (GPR).

Max dimensions 500x500; wind resistance class 2 according to EN 13561:2015

Rollerbat fabric roller diameter 70/80 mm in galvanised steel with patented system for reducing creases in the fabric

Fixing to the building is done on the wall or ceiling.

Winch or motorised movement by means of a tubular motor (optional).

In the motorised version it is possible to install light sensors and anemometers as well as connection to remote controls and control systems via smartphone apps.

Curtain profiles made from extruded aluminum alloy 6060, brackets in die-cast or shell-molded aluminum, and stainless steel screws.

Parts painted with polyester resin-based epoxy powders.

Choice of polyester acrylic or PVC fabrics according to KE sample book.

Frame color options include RAL 9010 White, RAL 9006 Aluminium. Other RAL colors are optional.

CE marking according to EN 13561:2015.



Rollerbat Ø 80mm



Viterie Inox

TECHNICAL INFORMATION

Wall installation

Double module A-A

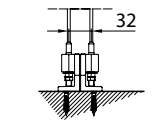
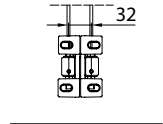
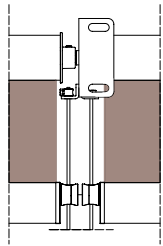

Top view

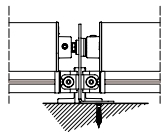

Rear view

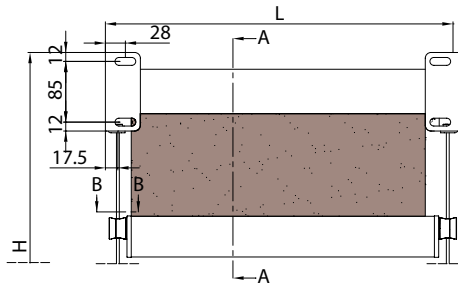
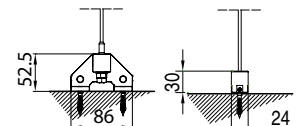
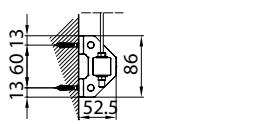
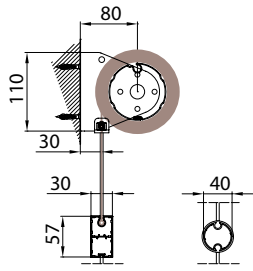

Wall bracket

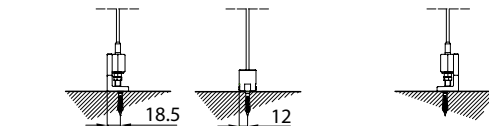
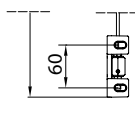

Top view

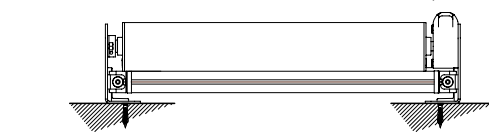

Wall bracket B-B

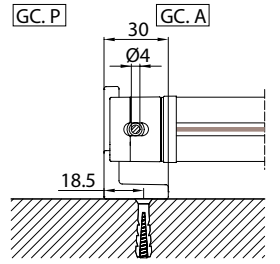

Floor foot B-B

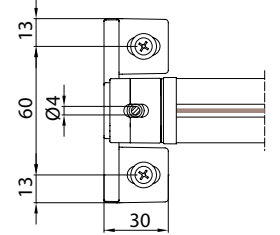

Ceiling installation

Double module A-A

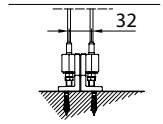
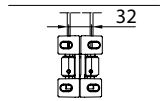
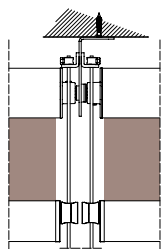

Top view

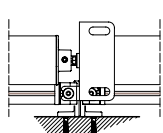

Rear view

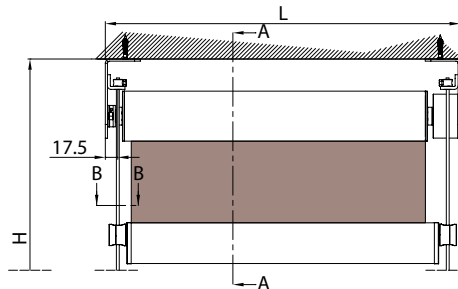
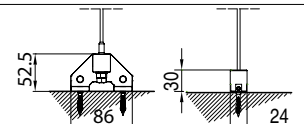
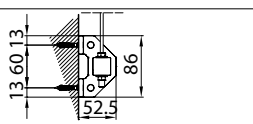
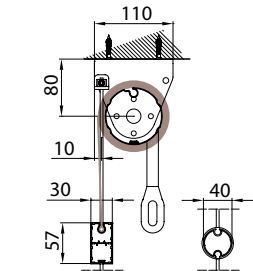

Wall bracket

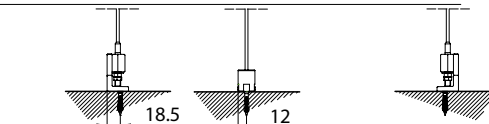
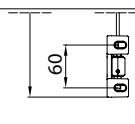

Top view



Wall bracket B-B

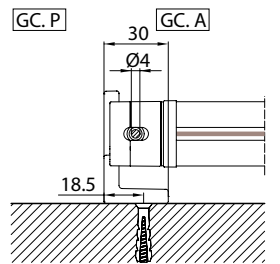

Floor foot B-B

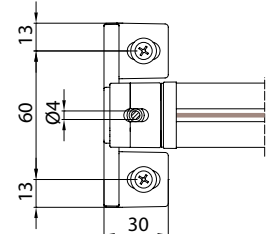



WIND RESISTANCE

The wind resistance of an exterior shade system is characterized by its ability to support defined loads by simulating wind with positive or negative pressure. In order to define a correlation between the wind resistance class according to the classes defined by the technical standard EN 13561 and the wind speed expressed in Km / h, a comparative table with the Beaufort scale is used. The Beaufort Scale classifies winds according to the speed at which they blow. Wind speed is measured in kilometers per hour (km / h) or in nodes using a measuring instrument, called anemometer, at a height of about 10 meters above the ground.

	TERMINE DESCRITTIVO	VELOCITA' VENTO m/sec	VELOCITA' VENTO m/sec	VELOCITA' VENTO Nodi	EFFETTI DEL VENTO SULLA TERRA	EN 13561
4	Vento moderato	5,5 - 7,9	20 - 28	11 - 16	Si sollevano polvere e pezzi di carta; si muovono i rami piccoli degli alberi.	Classe 1
5	Vento teso	8,0 - 10,7	29 - 38	17 - 21	Gli arbusti con foglie iniziano a ondeggiare; le acque interne s'increspano.	Classe 2
6	Vento fresco	10,8 - 13,8	39 - 49	22 - 27	Si muovono anche i rami grossi; gli ombrelli si usano con difficoltà.	Classe 3
7	Vento forte	13,9 - 17,1	50 - 61	28 - 33	Gli alberi iniziano a ondeggiare; si cammina con difficoltà contro vento.	Classe 4
8	Burrasca	17,2 - 20,7	62 - 74	34 - 40	Si staccano rami dagli alberi; generalmente è impossibile camminare contro vento.	Classe 5
9	Burrasca forte	20,8 - 24,4	75 - 88	41-47	Possono verificarsi leggeri danni strutturali agli edifici (caduta di tegole o di coperchi dei camini).	Classe 6



The KE painting process includes high quality standards, with an 8-stage pre-treatment that includes degreasing, deoxidation, and protective treatments before painting. Thanks to this last phase, components and profiles are further guaranteed against particularly severe environmental situations. At the end of the process the profiles and components are painted with polyester resin-based epoxy powders.

Treated components are periodically tested in salt spray according to the ISO 9227 standard to confirm conformity and consistency of the process.

The European product standard EN 13561: 2015 defines corrosion resistance classes of the metal parts that make up the product according to the table below.

Tests performed on the painted components and profiles allow us to classify the product in the maximum class achievable according to EN 13561: 2015, C2 / 4 (48 h - internal components, 240 h - external components).

Equipped with the most modern process control systems including continuous monitoring in which the working parameters are recorded and corrected every 2 minutes, the new painting process guarantees the high quality characteristics of the product while minimizing the risk of environmental pollution.

This is a choice born from the desire to always keep up with technology while guaranteeing operator safety and low environmental impact.

Thanks to nanotechnologies, the implemented coating constitutes an excellent base for anchoring paints, ensuring excellent adhesion and resisting corrosion.

The plant in which aluminum or galvanized steel products with a length of up to 7 meters can be treated, includes 7 treatment tanks, 1 double compartment drying oven, 1 polymerization oven and 1 purification plant for waste water treatment.

The real focus of the plant, however, is the two powder coating booths, each with 4 stations for manual retouching. The booths allow greater production continuity, thanks to a drastic reduction in required stops for color changes.

CORROSION RESISTANCE

Classes	1	2	3	4
Internal components	24	48		
External components		48	96	240

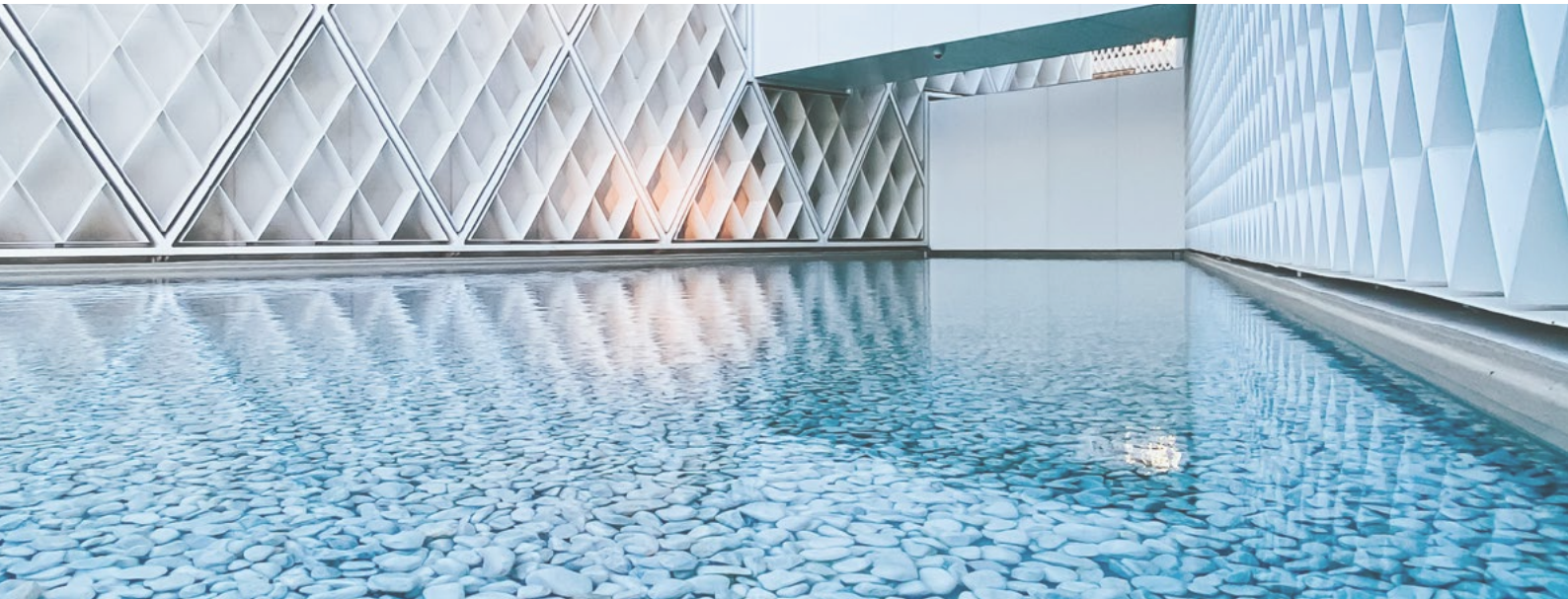

When working with color, we know that our whole world is defined by light. And color is nothing more than a breakdown of light. Objects reflect back to our eyes only the color that defines it. This is why it is so important to recognize the close link between color and matter. For this project, there are three keywords that guide the research: Words, Places, Matters.

WORDS: Naming colors is important to make them familiar and easily recognizable.

PLACES: Places define colors. Recognizing different types of places is a starting point for defining and suggesting color combinations.

MATERIALS: Objects do not exist in isolation, but rather match the environment around them: analyzing the materials that make up the environment itself helps us to make decisions; to decide, for example, if the character of a place is false or if instead it is genuinely artistic.

COLOURS RAL



● Ral standard (without supplement)



There is increasing demand for high-performance buildings that have a very low energy consumption and use energy derived from renewable sources. In particular, the limitation of solar heat gain is one of the most important aspects of summer thermal comfort. Solar shading plays an essential role in this concept. The gtot value determines the ability of the solar shield to maintain, in an environment directly exposed to solar radiation, a more comfortable temperature than that which would occur with the presence of glass alone. The solar heat gains are directly proportional to the total transmittance of solar energy gtot, a value that depends on the glazing and external shielding. The European product standard EN 13561: 2015 and the EN 14501 standard identify 5 energy performance classes as shown in the table below.

Effect of GTOT on thermal comfort					
Gtot value	$\geq 0,50$	$\geq 0,35 \text{ e } < 0,50$	$\geq 0,15 \text{ e } < 0,35$	$\geq 0,10 \text{ e } < 0,15$	$< 0,10$
Class	0	1	2	3	4
	very mild effect	Mild effect	Moderate effect	good effect	very good effect

Each KE product has a Gtot value according to the shading fabric / profiles used. For details, refer to the information provided with the technical data sheet of the fabric and the CE label.

FABRICS

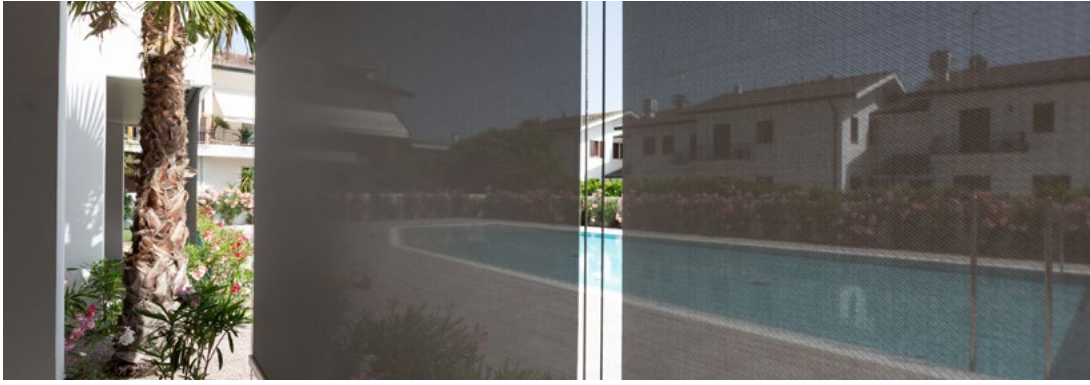

KE
ENJOY THE OUTDOORS

Thermal comfort blends perfectly with beautiful style thanks to the more than 500 high performance fabrics available. A wide variety of colors, styles and solar shading factors allow for a system that meets your specific needs. All fabrics are CE Certified according to the EN 13561 and EN 14501 technical standards.

N.B.
See the Fabric Guide for further fabric specifications.

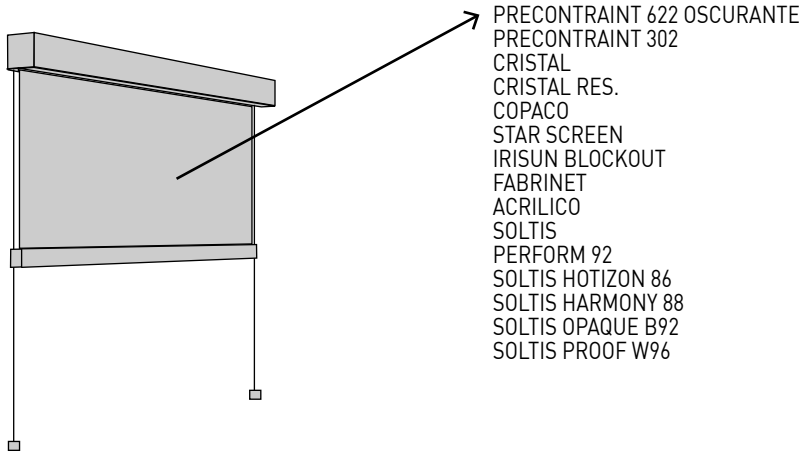

Fabrics

- PRECONTRAIT 622 OSCURANTE
PRECONTRAIT 302
CRISTAL
CRISTAL RES.
COPACO
STAR SCREEN
IRISUN BLOCKOUT
FABRINET
ACRILICO
SOLTIS
PERFORM 92
SOLTIS HOTIZON 86
SOLTIS HARMONY 88
SOLTIS OPAQUE B92
SOLTIS PROOF W96

DICHIARAZIONE DI PRESTAZIONE

N. 00002-CPR-2022-01-27

Ai sensi dell'Allegato III del Regolamento (UE) n.305/2011 del 9 marzo 2011
 modificato dal Regolamento Delegato (UE) n.574/2014 del 21 febbraio 2014

SCREENY

Uso previsto del prodotto: Tende per uso esterno

Nome e indirizzo del fabbricante: KE PROTEZIONI SOLARI S.r.l., Via Calnova 160/a, Noventa di Piave (VE) – Italia

Sistema di valutazione e verifica della costanza di prestazione: 4

Specifica tecnica armonizzata: EN 13561:2015 – Tende esterne e tendoni – Requisiti prestazionali compresa la sicurezza

Classificazione secondo Prospetto 1 - §4.1 EN 13561:2015:

Classi di resistenza al vento	0	1	2	3	4	5	6
Pressione nominale del vento p_N (N/m ²)	<40	40	70	110	170	270	400
Pressione di sicurezza del vento p_S (N/m ²)	<48	48	84	132	204	324	480
Velocità massima del vento [km/h]	<25	25	35	45	55	70	90

Prestazione dichiarata:

Codice di identificazione unico del prodotto-tipo	L (cm)	H (cm)	Classe di resistenza al vento	Specifica tecnica armonizzata	
S07	SCREENY 85 GC S	300	240	3	UNI EN 13561:2015
S04	SCREENY 85 GPZ S	300	240	2	UNI EN 13561:2015
S12	SCREENY 110 GC	400	300	3	UNI EN 13561:2015
S17	SCREENY 110 GC CABRIO	400	300	3	UNI EN 13561:2015
S32	SCREENY 110 GPZ UNICA	300	300	6	UNI EN 13561:2015
		400	300	5	
S60	SCREENY 110 GPZ TENS T VERSIONE TO	400	300	2	UNI EN 13561:2015
S22	SCREENY 130 GC	500	500	2	UNI EN 13561:2015
S27	SCREENY 130 GC CABRIO	500	500	2	UNI EN 13561:2015
S41	SCREENY 130 GPZ UNICA	300	300	6	UNI EN 13561:2015
		500	500	5	
S70	SCREENY 130 GPZ TENS T VERSIONE TO	400	500	1	UNI EN 13561:2015
S24	SCREENY 130 GPR	500	500	2	UNI EN 13561:2015
S53	SCREENY 150 GC	600	500	1	UNI EN 13561:2015
S51	SCREENY 150 GPZ UNICA AM	600	500	1	UNI EN 13561:2015
S80	SCREENY BOX 110	400	300	1	UNI EN 13561:2015
S90	SCREENY BOX 130	500	300	1	UNI EN 13561:2015

Trasmittanza totale di energia solare g_{tot} : fare riferimento al valore riportato in etichetta CE in base al tipo di tessuto utilizzato. La fornitura dei prodotti sopra indicati è conforme all'insieme delle prestazioni dichiarate.

Si rilascia la presente dichiarazione di prestazione in conformità al regolamento (UE) n.305/2011 sotto la responsabilità esclusiva del fabbricante sopra identificato.



EN 13561:2015

Noventa di Piave, 27 Gennaio 2022

KE PROTEZIONI SOLARI S.r.l.
 Simone Mazzon
 Amministratore delegato



EN ISO 9001

KE has adopted a Quality Management System compliant with EN ISO 9001 requirements in order to maintain and increase quality and meet the highest customer expectations. This continuous improvement, through the control of all processes and careful evaluation of risks and opportunities, engages the entire organization in the development of systems to ensure the safety and reliability of the product and in the search for innovative solutions and technologies.

OHSAS 18001

KE has activated a Safety Management System as an integral part of its work organization, committing itself to organizing the entire structure in order to pursue the objectives of continuous improvement in terms of safety and health protection. Training, knowledge and compliance with current legislation on health and safety at work, cooperation and collaboration and preventive activities are actively pursued in order to minimize the possibility of non-compliance.

EN ISO 14001

KE is ISO 14001 certified for environmental management and strives to be an example of respect for environmental resources and for the continuous improvement of its environmental management system. It is committed to continuous improvement and pollution prevention in compliance with applicable laws, regulations and standards; systematically detects any environmental impact of manufacturing processes, promotes the culture of recovery and recycling in the company and in the related production chain.

CE MARK _ EN 13561

The CE marking of outdoor awnings is a signal to the Consumer that the product can be sold freely in the EU single market, as it complies with Community provisions which recognize safety as the priority of every product that has this agreed upon reference standard. Verification of wind resistance capacity and the clear indication of the ability of the awning to contribute to the energy savings of the building (Gtot), are some of the commitments that the manufacturer makes to a product that has earned the CE marking. The name of the manufacturer, the reference standard (in our case EN 13561) accompany a product that is properly adapted to European indications.

VIRTUAL SHOW ROOM



KE
ENJOY THE OUTDOORS

KE has adapted to the new ways of using the product by working on a digital showroom that is able to give the user a high-impact visual experience, a functional space where they can move around freely, receive detailed information on products with a simple click, and access content of interest quickly and intuitively. There is viewable content such as augmented reality and downloadable files such as data sheets, brochures and 3D models.



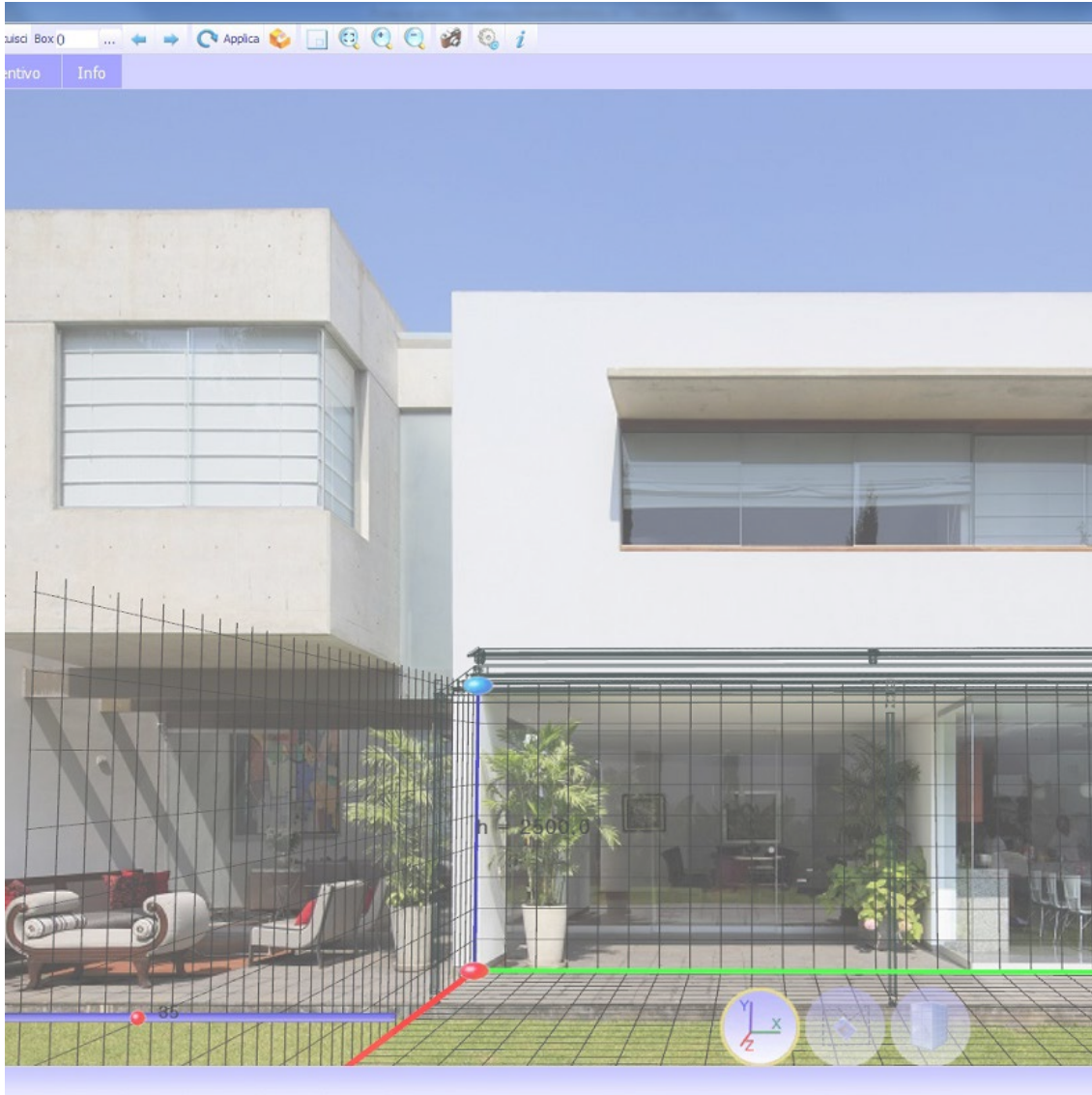

The KE B2B order system is a simple and intuitive service for placing orders conveniently online. An attractive graphic design, numerous functionalities and an easy and intuitive use mode that allows to access in real time to all the information related to the history of the orders and to the processing of the current ones. With the Cad Lite 3D Configurator you can configure Genius and Bioclimatica models thanks to a constantly updated online catalogue. Thanks to an easy-to-use interface, it also allows you to formulate a complete quote with minimal error.

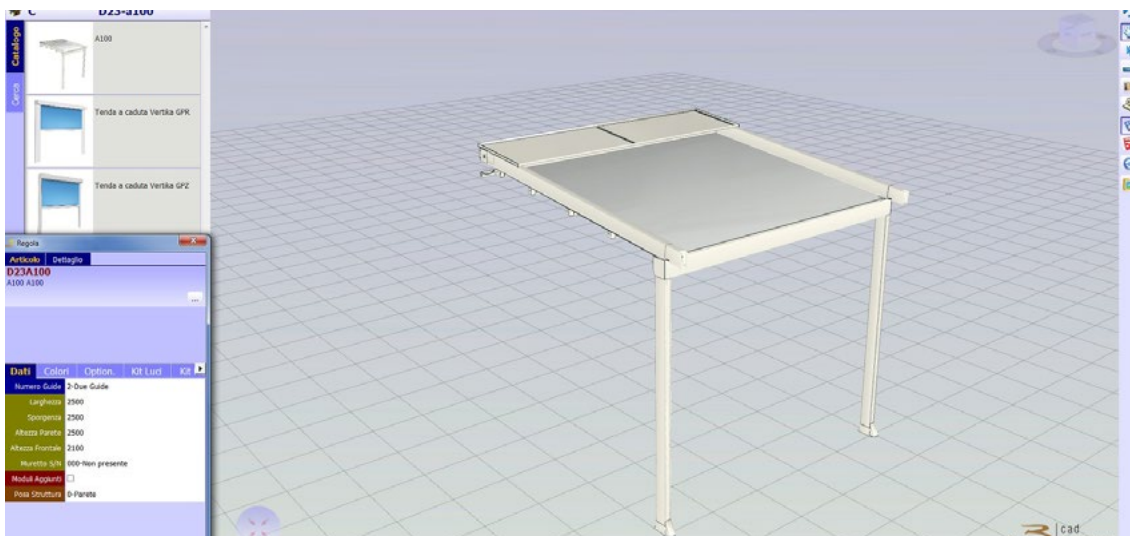



Home > Ambienti

Ambienti

La nostra missione è creare nuovi spazi outdoor da vivere in totale armonia. Grazie alle nostre coperture solari e alle strutture per esterni personalizzate, potrai arredare con stile il tuo terrazzo, giardino, attico, ma anche modulare... [Leggi di più](#)



BIM technology improves the working method of designers and is now the main source of information for the realisation of a project. With BIM the model is generated in a "parametric 3D" from which a series of information such as 2D views, elevations, sections but also metric calculations and much more can be automatically derived. On the KE website you can find the BIM gallery of the main KE models, the certifications and all the useful technical documentation for each product: www.keoutdoordesign.com

Area Clienti IT-IT

Referenze Area Media

- Brochure e Cataloghi
- BIM & 3D Models
- Blog
- News
- Video

POWERED BY SYNCRONIA





A GROUP, A VISION, A GROUP IN EVOLUTION

Since 1987, KE has been designing and manufacturing arm awnings, cassette awnings, drop awnings, canopies, shelters and is specialised in shading structures that enhance the liveability of outdoor spaces, up to the redesign and restyling of urban furniture. Both for the variety of the range and the depth of the configurations, KE is a manufacturing reality able to satisfy the most demanding requests the most demanding requirements of designers, architects, window and door manufacturers, upholsterers and outdoor professionals.



Improving the experience

With KE's professionalism and experience you can rely on quality products designed to enhance your customers' outdoor experience. With KE it will be easier to live the outdoor space in perfect harmony with the surrounding environment, widening the viewpoints and ensuring maximum comfort in all seasons.