

 450 x 450 cm

Schema tecnico generale/General technical plan/Allgemein - technisches Schema/Plan technique général/Dibujo tecnico general

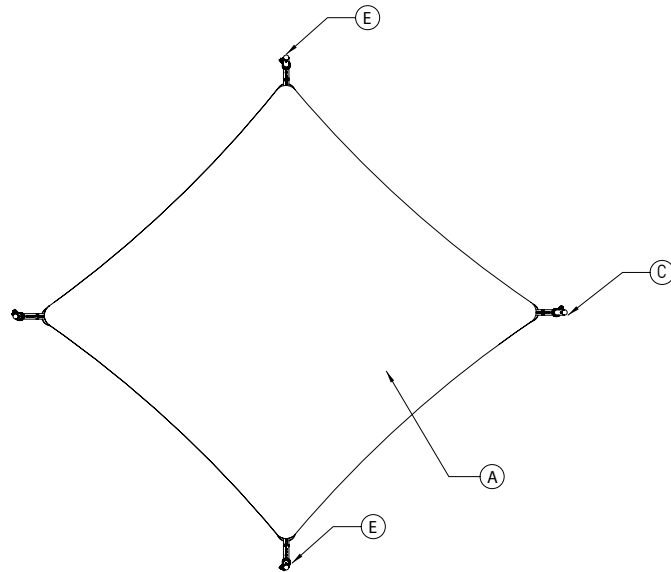

- A Telo / Fabric / Tuch / Toile / Tela
 C Albero porta motore / Drive shaft / Stütze mit Motor / Mat porte moteur / Columna porta motor
 E Albero rinvio / Countershaft / Vorgegestütze / Mat renvoie / Columna reinvio

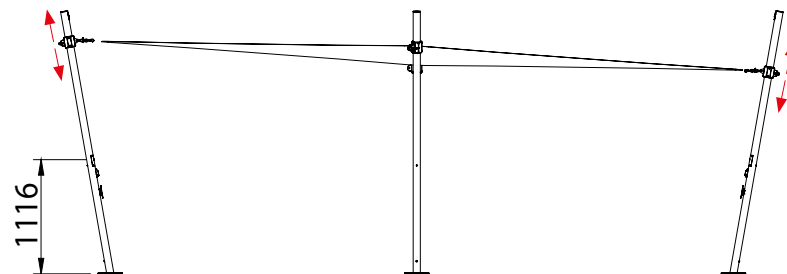
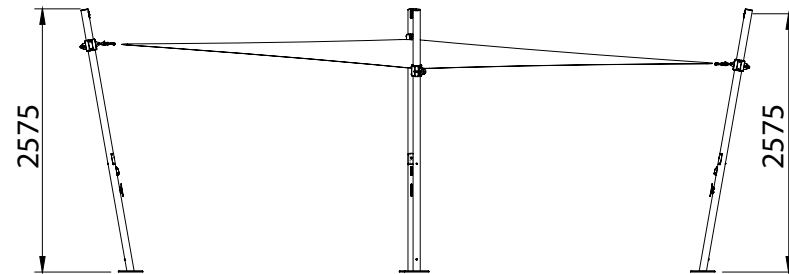
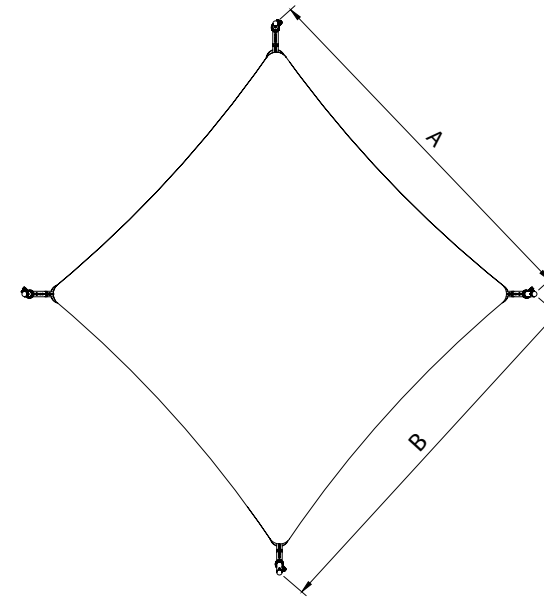

 450 x 450 cm

Schema tecnico generale/General technical plan/Allgemein - technisches Schema/Plan technique général/Dibujo tecnico general

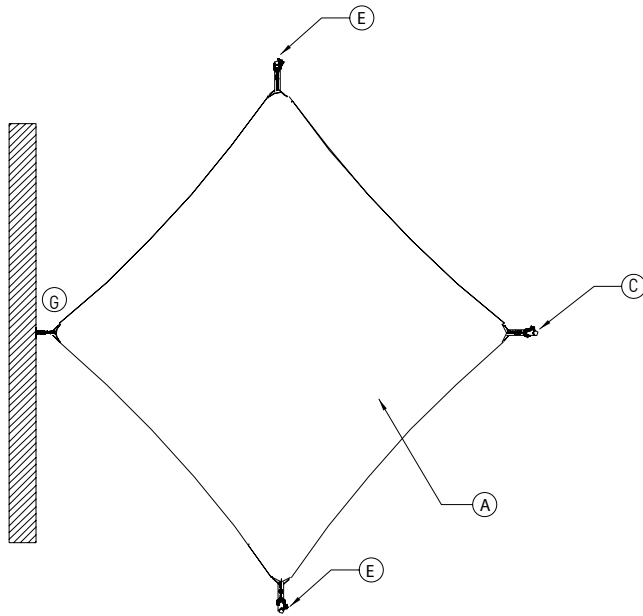

- A Telo / Fabric / Tuch / Toile / Tela
- C Albero porta motore / Drive shaft / Stütze mit Motor / Mat porte moteur / Columna porta motor
- E Albero rinvio / Countershaft / Vorgegelestütze / Mat renvoie / Columna reinvio
- G Staffa a parete / Wall bracket / Wandkonsole / Support bome / Soporte pared

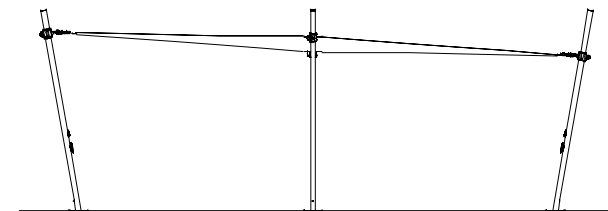
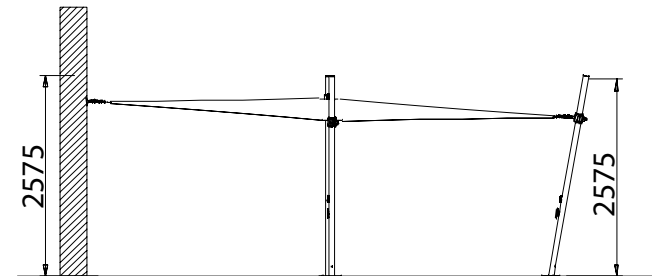
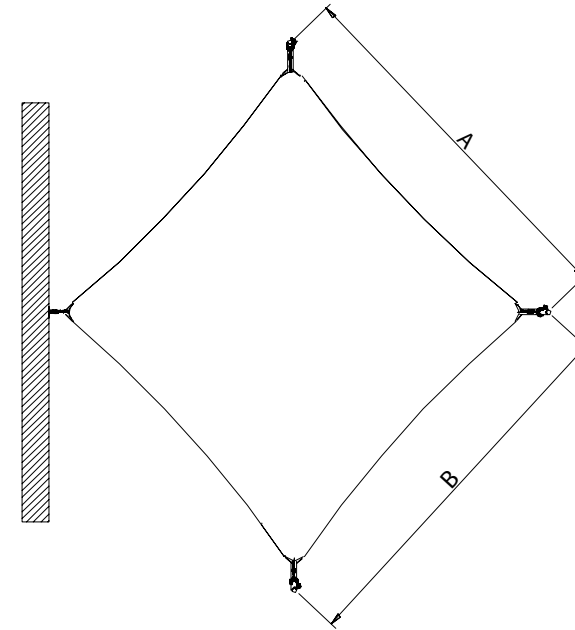



Schema tecnico generale/General technical plan/Allgemein - technisches Schema/Plan technique général/Dibujo tecnico general

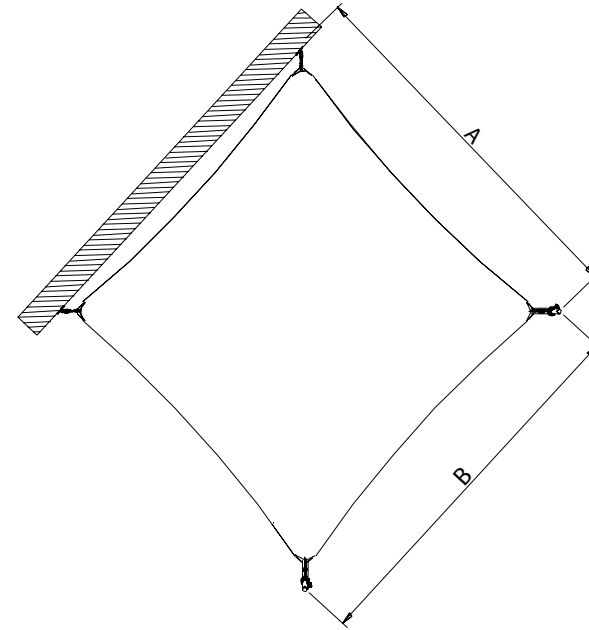
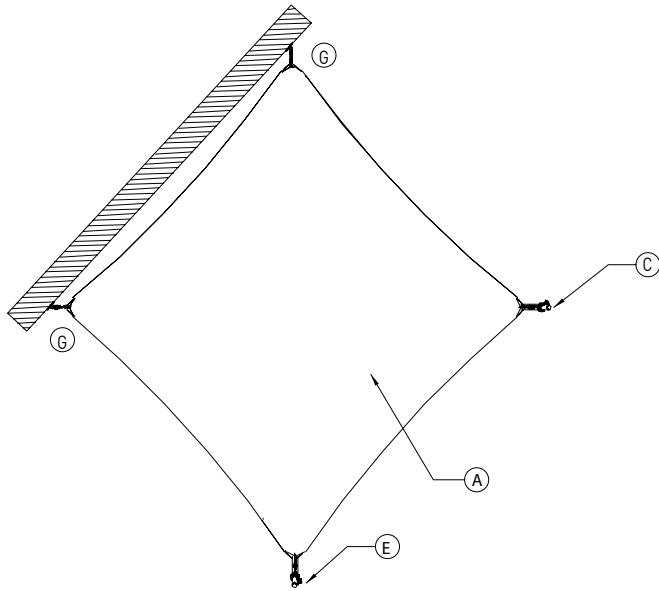

- A Telo / Fabric / Tuch / Toile / Tela
 C Albero porta motore / Drive shaft / Stütze mit Motor / Mat porte moteur / Columna porta motor
 E Albero rinvio / Countershaft / Vorgegestütze / Mat renvoie / Columna reinvio
 G Staffa a parete / Wall bracket / Wandkonsole / Support bome / Soporte pared

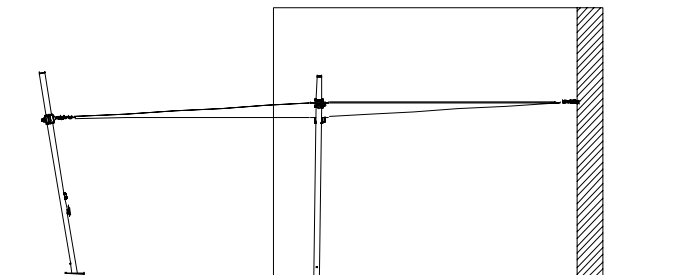
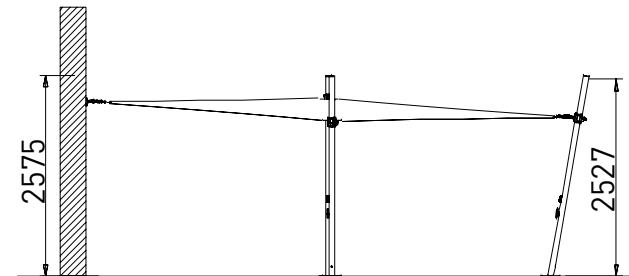



Schema tecnico generale/General technical plan/Allgemein - technisches Schema/Plan technique général/Dibujo tecnico general

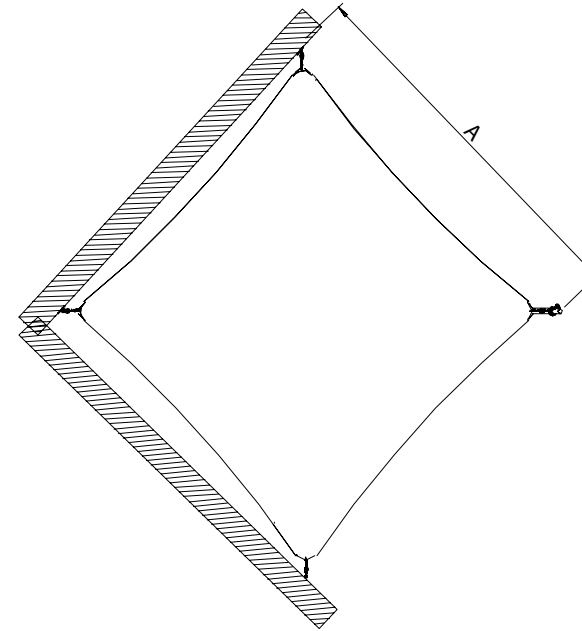
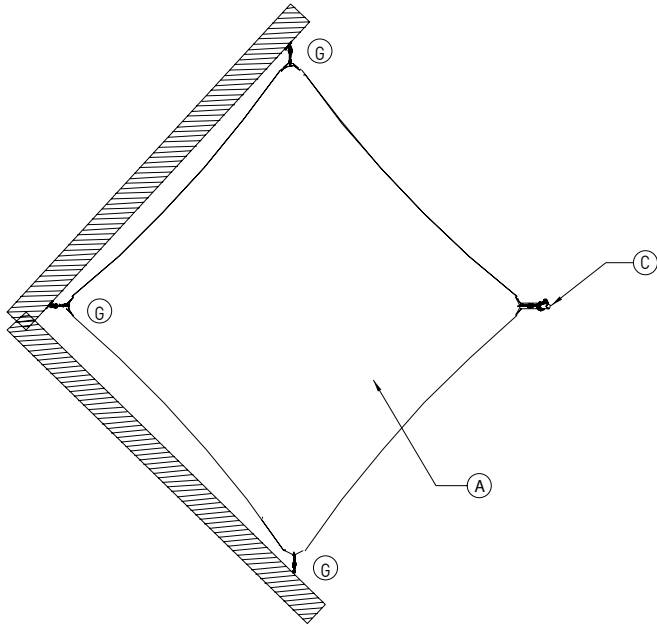

- A Telo / Fabric / Tuch / Toile / Tela
 C Albero porta motore / Drive shaft / Stütze mit Motor / Mat porte moteur / Columna porta motor
 G Staffa a parete / Wall bracket / Wandkonsole / Support bome / Soporte pared

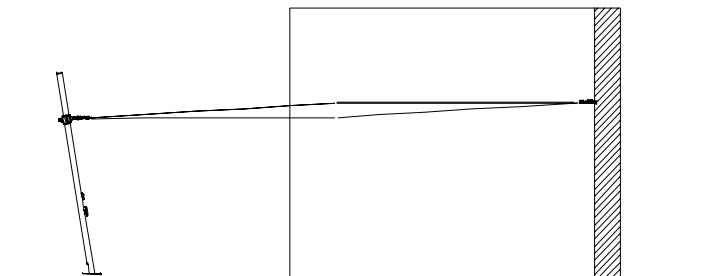
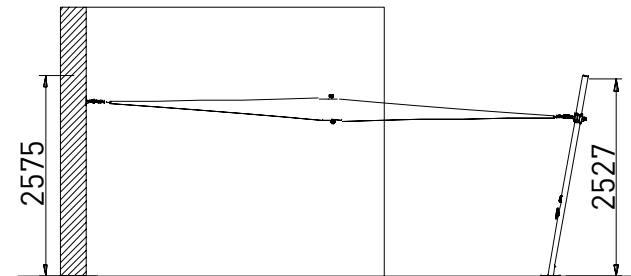



Schema tecnico generale/General technical plan/Allgemein - technisches Schema/Plan technique général/Dibujo tecnico general

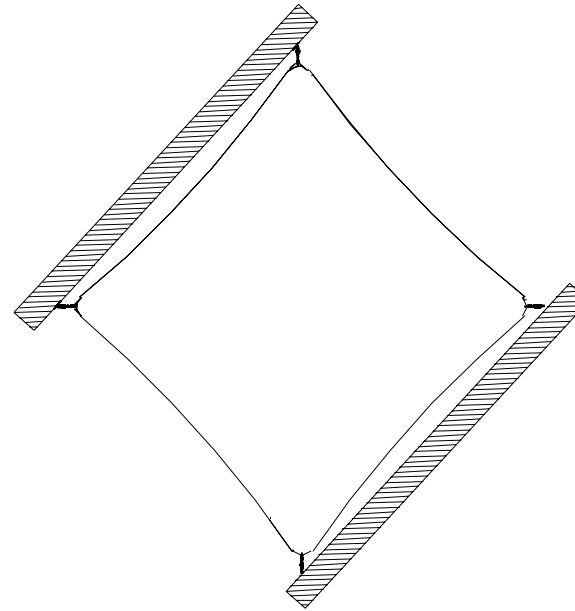
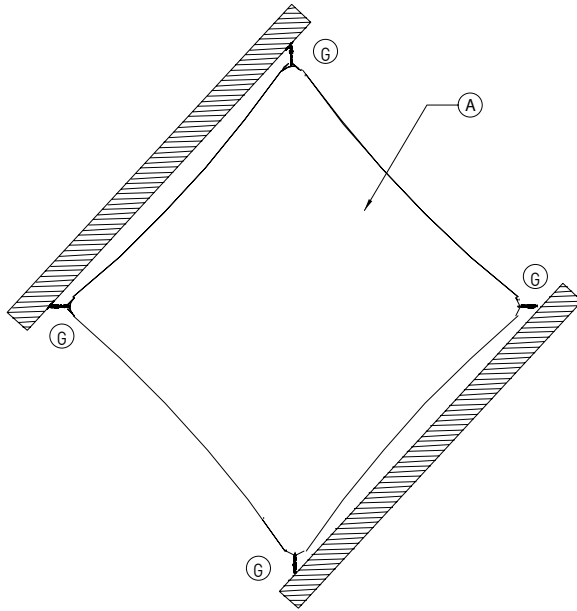

A Telo / Fabric / Tuch / Toile / Tela

G Staffa a parete / Wall bracket / Wandkonsole / Support bome / Soporte pared

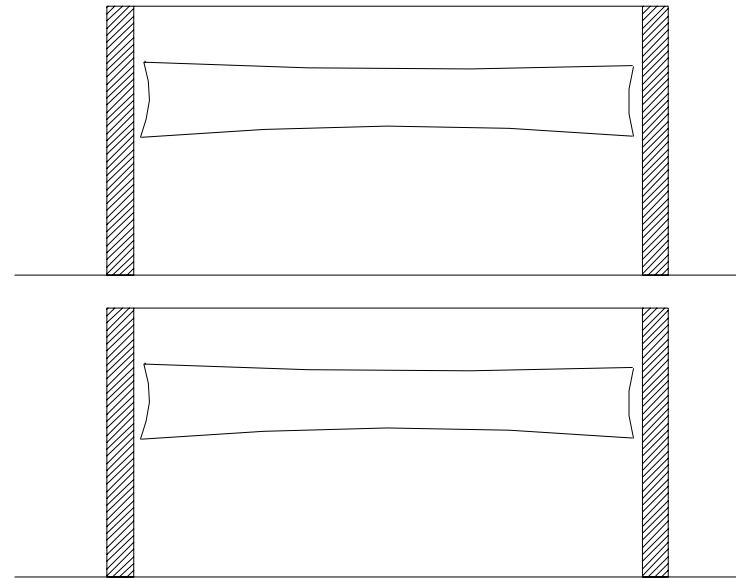



Schema tecnico generale/General technical plan/Allgemein - technisches Schema/Plan technique général/Dibujó tecnico general

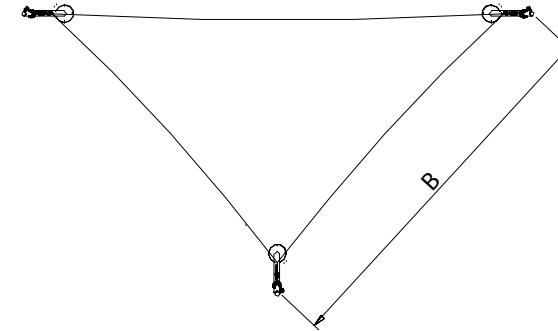
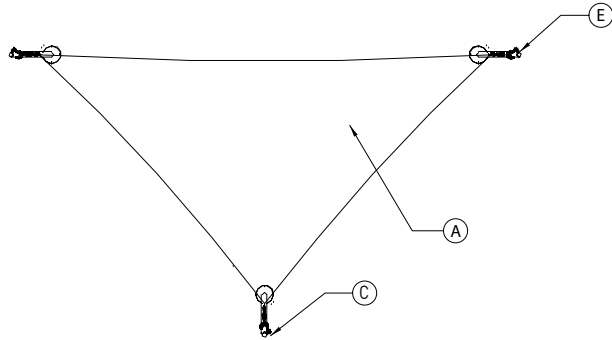

- A Telo / Fabric / Tuch / Toile / Tela
 C Albero porta motore / Drive shaft / Stütze mit Motor / Mat porte moteur / Columna porta motor
 E Albero rinvio / Countershaft / Vorgegestütze / Mat renvoie / Columna reinvio

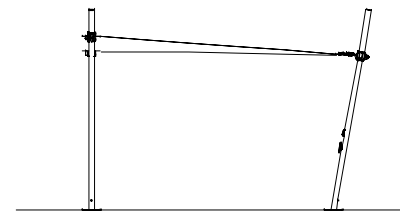
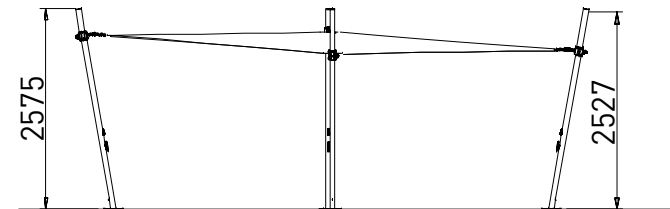

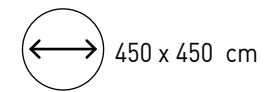

Schema tecnico generale/General technical plan/Allgemein - technisches Schema/Plan technique général/Dibujo tecnico general

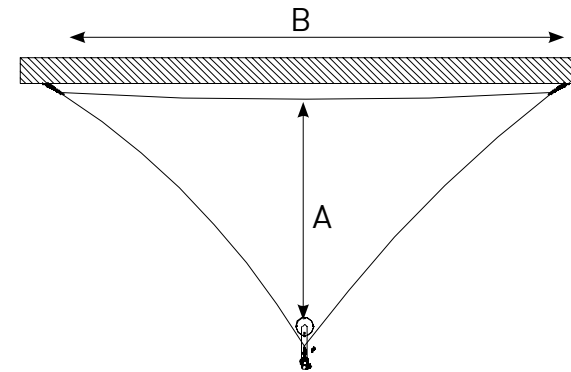
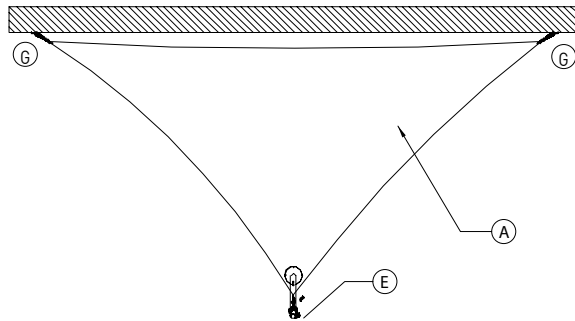

- A Telo / Fabric / Tuch / Toile / Tela
 E Albero rinvio / Countershaft / Vorgegestütze / Mat renvoie / Columna reeinvio / Countershaft / Vorgegestütze / Mat renvoie / Columna reeinvio
 G Staffa a parete / Wall bracket / Wandkonsole / Support bome / Soporte pared

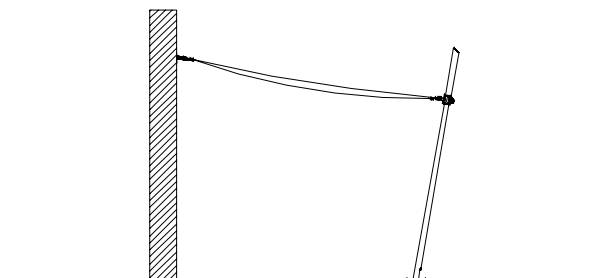
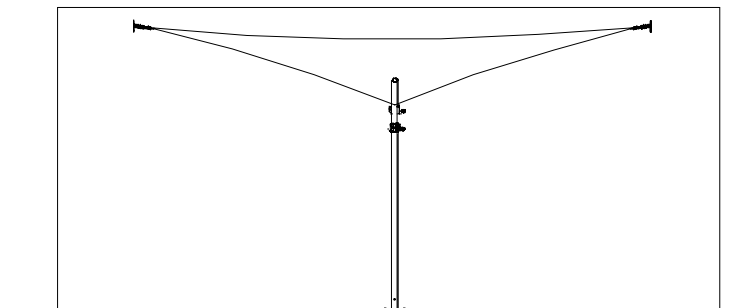



Schema tecnico generale/General technical plan/Allgemein - technisches Schema/Plan technique général/Dibujo tecnico general

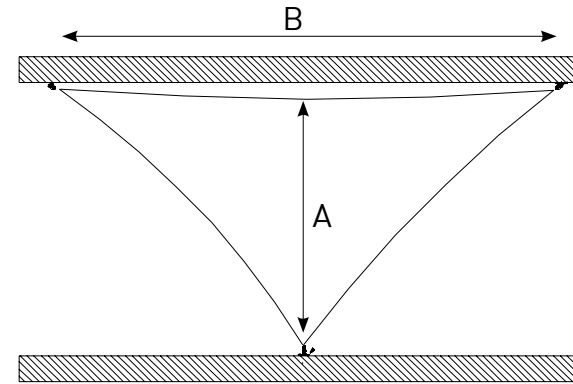
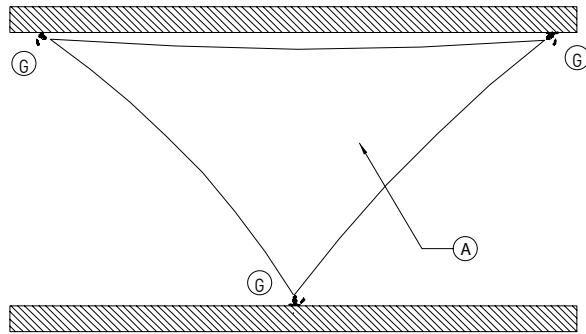

A Telo / Fabric / Tuch / Toile / Tela

G Staffa a parete / Wall bracket / Wandkonsole / Support bome / Soporte pared

