

BELLA PLUS

ACRYLIC

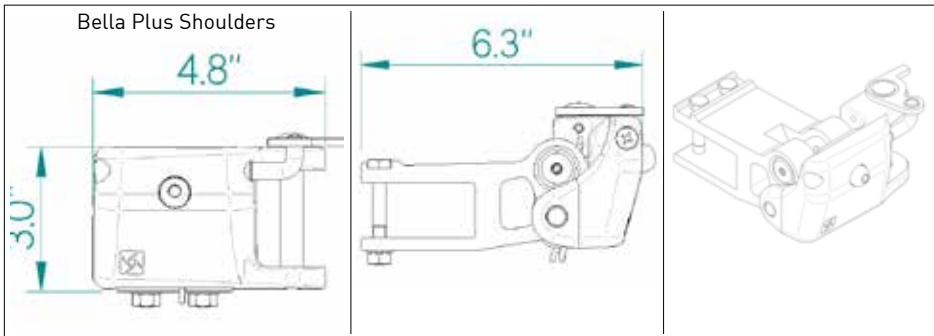
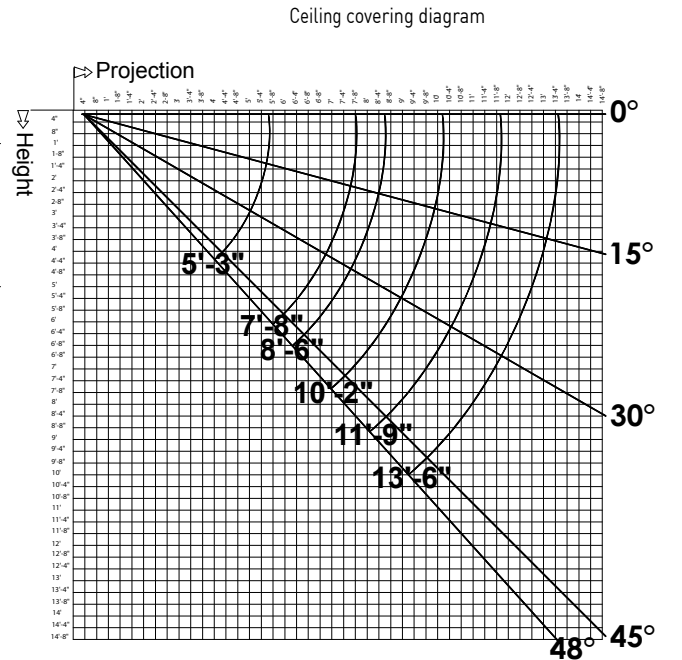
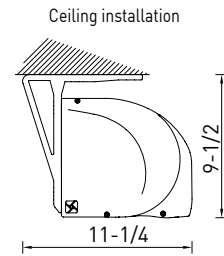
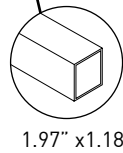
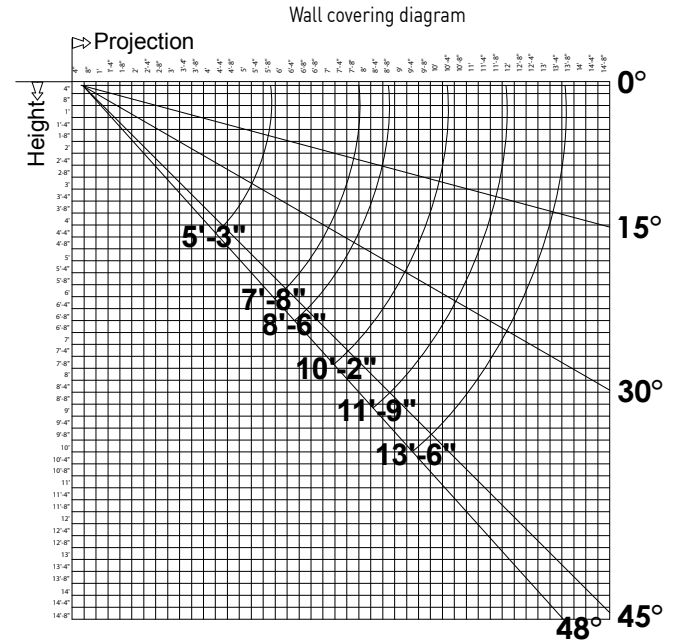
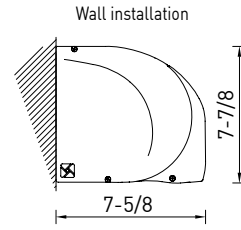

Note: Awning may not hang exactly at 0° due to the weight of the front bar.

PRODUCT NOTES

- Widths available: 7'4" - 26'
- Projections available: 5'3", 7'8", 8'6", 10'2", 11'9", 13'5", 14'3" (up to 20' width only)
- Arm style: belt arms on all widths and projections
- Operation: motor and manual option (available on two arm units only, up to 13' width and up to 10'2" projection)
- Mounting options: roof, soffit, and wall
- Wind ratings: Class 1
- Backside profile is optional but strongly recommended on units with soffit and roof mount options
- Drop valance option available on full cassette and semi cassette units only up to 19' 10" width and up to 11'9" projection
- Custom color available on all units up to 10'2" projection
- 11'9", 13'5", and 14'3" projections have Triumph arms and not available in custom color
- Profiles (except front bar) on units over 23' width will require splicing at the middle junction. Torsion bars will be spliced on all units over 19' 8"
- Torque sensing motor is available on all units with motor B. On all other sizes/projections the torque sensing motor is not available
- Elevator split option and split roller option are not available on Bella Plus units.
- Arms with LED lights available with transformer (included) and 24V DC Receiver (optional).

** For complete unit notes, specifications, and installation instructions, please see the Product Reference Guide **

AVAILABLE COLORS

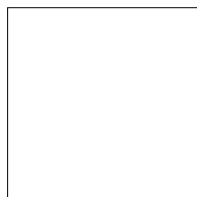

WHITE
(RAL 9010)



BROWN
(Bronze)



SAND



CHARCOAL



JET BLACK
RAL 9005
HIGH GLOSS